

# FS Series

## DIN W48 × H48mm 8 Pin plug counter

### ■ Features

- Upgraded counting speed : 1cps / 30cps / 2kcps / 5kcps
- Decimal point setting (Fixed decimal point of display)
- Wide range of power supply : 100–240VAC 50/60Hz  
12–24VAC/DC (Option)
- Memory protection for 10years (Using non-volatile semiconductor)
- Selectable Up/Down for counting value
- Built-in microprocessor



**⚠ Please read "Caution for your safety" in operation manual before using.**

### ■ Ordering information

<b>FS</b>	<b>4</b>	<b>A</b>	
		Output	A Single preset B Indicator
		Digit	4 9999(4 Digit) 5 99999(5 Digit)
Item			FS 8 Pin Plug Counter

### ■ Specifications

Model	Single preset Totalizer(Indicator)	FS4A	FS5B
Digit		4	5
Digit size		W3.8 × H7.6mm	W4 × H8mm
Power supply		100–240VAC 50/60Hz, 12–24VAC/DC (Option)	
Allowable voltage range		90 to 110% of rated voltage	
Power consumption		<ul style="list-style-type: none"> <li>• Indicator : Approx. 4.7VA (240VAC 60Hz), Approx. 2.8W (24VDC), Approx. 4.5VA (24VAC 60Hz)</li> <li>• Single preset : Approx. 5.7VA (240VAC 60Hz), Approx. 3W (24VDC), Approx. 5.5VA (24VAC 60Hz)</li> </ul>	
Max. counting speed for CP1, CP2		Selectable 1cps/30cps/2kcps/5kcps by internal DIP switch	
Min. input signal width	RESET input	Approx. 20ms	
Input	COUNT IN	No-voltage input	
	RESET	<ul style="list-style-type: none"> <li>• Impedance at short-circuit : Max. 470kΩ</li> <li>• Residual voltage at short-circuit : Max. 1VDC</li> <li>• Impedance at open-circuit : Min. 100kΩ</li> </ul>	
One-shot output time		0.05 to 5sec.	
Control output	Contact	SPST (1a)	
	Capacity	250VAC 3A resistive load	
Memory protection		10 years (When using non-volatile semiconductor memory)	
External power		12VDC ±10% 50mA max.	
Insulation resistance		100MΩ (at 500VDC megger)	
Dielectric strength		2000VAC 50/60Hz for 1 minute	
Noise strength	AC power	±2kV the square wave noise (pulse width : 1μs) by the noise simulator	
	DC power	±500V the square wave noise (pulse width : 1μs) by the noise simulator	
Vibration	Mechanical	0.75mm amplitude at frequency of 10 to 55Hz in each of X, Y, Z directions for 1 hour	
	Malfunction	0.5mm amplitude at frequency of 10 to 55Hz in each of X, Y, Z directions for 10 minutes	
Shock	Mechanical	300m/s <sup>2</sup> (Approx. 30G) in X, Y, Z directions 3 times	
	Malfunction	100m/s <sup>2</sup> (Approx. 10G) in X, Y, Z directions 3 times	
Relay life cycle	Mechanical	Min. 10,000,000 times	
	Electrical	Min. 100,000 times (250VAC 3A at resistive load)	
Ambient temperature		–10 to 55°C (at non-freezing status)	
Storage temperature		–25 to 65°C (at non-freezing status)	
Ambient humidity		35 to 85%RH	
Unit weight	AC power	Approx. 122g	Approx. 112g
	DC power	Approx. 130g	Approx. 120g

# 8 Pin Plug type Counter

## Connections

### ●FS4A

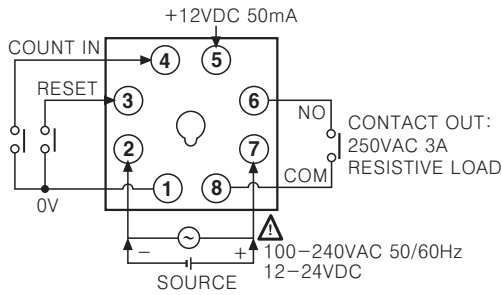

### ●FS5B

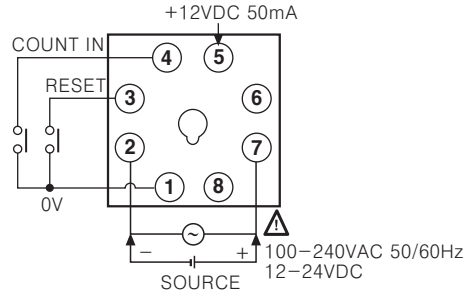

## Dimensions

### ●Bracket

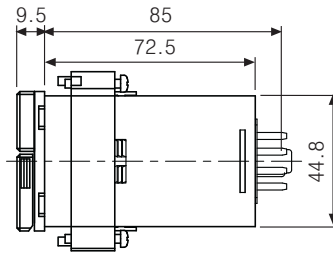
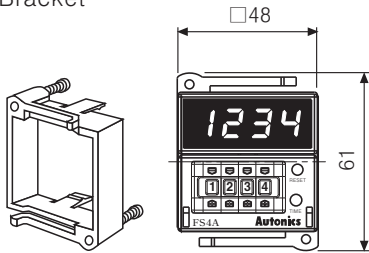

### ●Panel cut-out

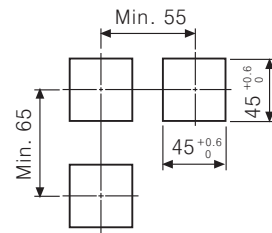

### ●Socket (Sold separately)

(Unit:mm)

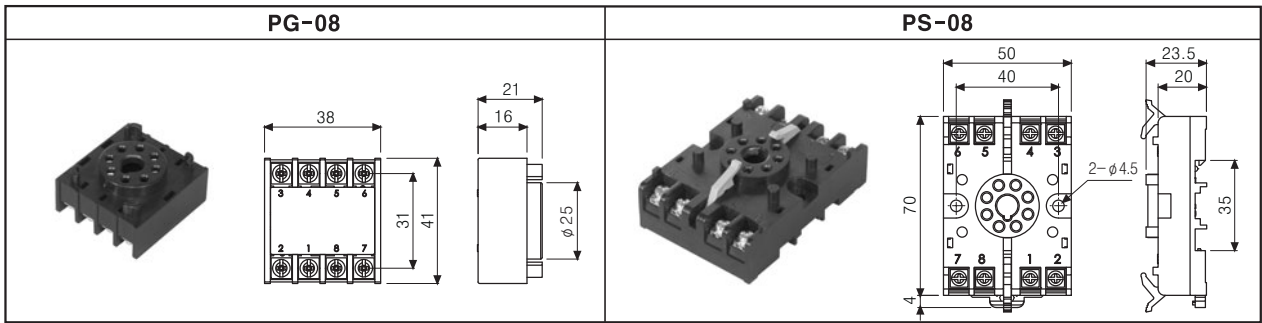

## Input connections

### ○No-voltage input (NPN)

#### ●Solid-state input (Standard sensor : NPN output type sensor)

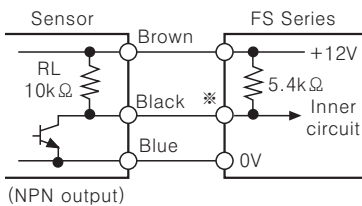

(NPN output)

\*CP1, CP2(INHIBIT), RESET input

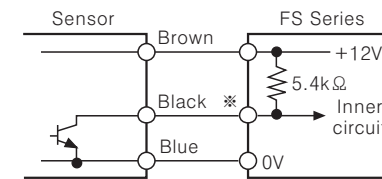

(NPN open collector output)

#### ●Contact input

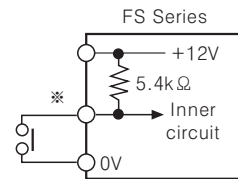

Counting speed :  
1 or 30cps setting (Counter)

### ○Voltage input (PNP)

FX series is for no voltage input type, it is not available to count applying DC voltage from the external. For using PNP type sensor, please use as the following to count.

#### ●PNP output sensor

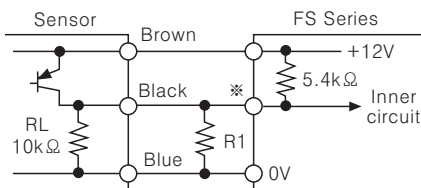

\*Please set R1 value to make the composed resistance of RL+R1 as Max. 470Ω is an impedance for short-circuit.

\*CP1, CP2(INHIBIT), RESET input

#### ●PNP open collector output type sensor

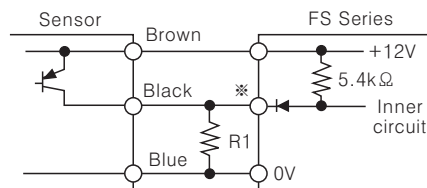

\*In case of PNP open collector output type sensor, please connect lower than 470Ω of R1 to input terminal before using.

(A)	Photo electric sensor
(B)	Fiber optic sensor
(C)	Door/Area sensor
(D)	Proximity sensor
(E)	Pressure sensor
(F)	Rotary encoder
(G)	Connector/Socket
(H)	Temp. controller
(I)	SSR/ Power controller
(J)	Counter
(K)	Timer
(L)	Panel meter
(M)	Tacho/ Speed/ Pulse meter
(N)	Display unit
(O)	Sensor controller
(P)	Switching power supply
(Q)	Stepping motor & Driver & Controller
(R)	Graphic/ Logic panel
(S)	Field network device
(T)	Production stoppage models & replacement

# FS Series

## ◎Input & output connections

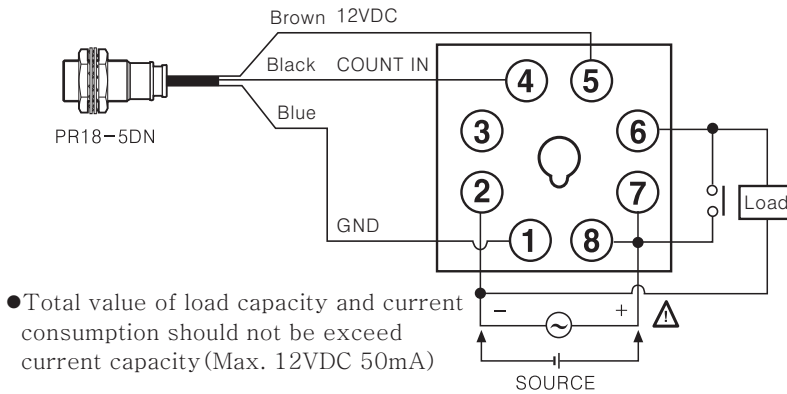

●Total value of load capacity and current consumption should not be exceed current capacity (Max. 12VDC 50mA)

●Please select proper capacity of load not to exceed contact capacity.  
Contact capacity : 250VAC 3A Max.  
Contact type : 1a

## ■Description of inner DIP switches

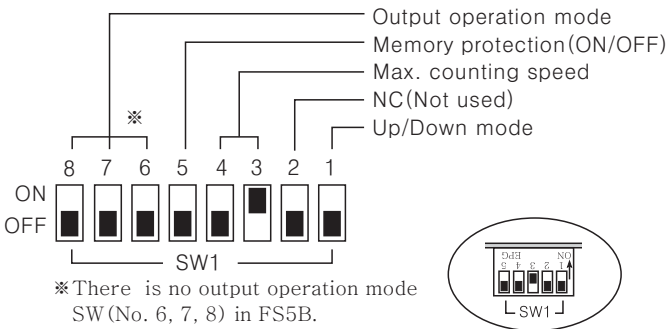

\*There is no output operation mode SW (No. 6, 7, 8) in FS5B.

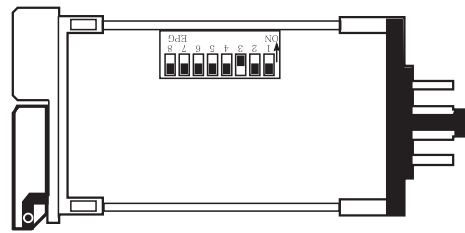

\*The max. counting speed is upgraded as 8 DIP SW numbers.

### ●Max. counting speed

SW1	Function						
<table border="1"> <tr><td>3</td><td>4</td></tr> <tr><td>ON</td><td>OFF</td></tr> <tr><td>OFF</td><td>ON</td></tr> </table>	3	4	ON	OFF	OFF	ON	1cps
3	4						
ON	OFF						
OFF	ON						
<table border="1"> <tr><td>3</td><td>4</td></tr> <tr><td>ON</td><td>ON</td></tr> <tr><td>OFF</td><td>ON</td></tr> </table>	3	4	ON	ON	OFF	ON	30cps
3	4						
ON	ON						
OFF	ON						
<table border="1"> <tr><td>3</td><td>4</td></tr> <tr><td>ON</td><td>ON</td></tr> <tr><td>OFF</td><td>ON</td></tr> </table>	3	4	ON	ON	OFF	ON	2kcps
3	4						
ON	ON						
OFF	ON						
<table border="1"> <tr><td>3</td><td>4</td></tr> <tr><td>ON</td><td>ON</td></tr> <tr><td>OFF</td><td>ON</td></tr> </table>	3	4	ON	ON	OFF	ON	5kcps
3	4						
ON	ON						
OFF	ON						

### ●Up/Down mode

SW1	Function			
<table border="1"> <tr><td>1</td></tr> <tr><td>ON</td></tr> <tr><td>OFF</td></tr> </table>	1	ON	OFF	Down mode
1				
ON				
OFF				
<table border="1"> <tr><td>1</td></tr> <tr><td>ON</td></tr> <tr><td>OFF</td></tr> </table>	1	ON	OFF	Up mode
1				
ON				
OFF				

### ●Memory protection

SW1	Function			
<table border="1"> <tr><td>5</td></tr> <tr><td>ON</td></tr> <tr><td>OFF</td></tr> </table>	5	ON	OFF	Disable the memory protection
5				
ON				
OFF				
<table border="1"> <tr><td>5</td></tr> <tr><td>ON</td></tr> <tr><td>OFF</td></tr> </table>	5	ON	OFF	Enable the memory protection
5				
ON				
OFF				

## ■Setting function of decimal point

Display the decimal point.

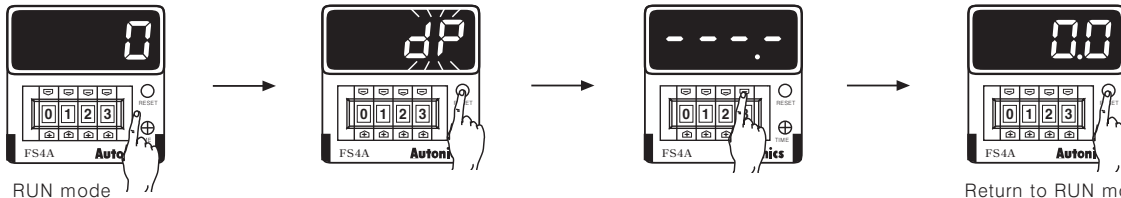

\*Press RESET button for over 3sec., it advances to decimal point setting mode.

\*When "dp" is flashing, one touch the Reset button.

\*Set the position of decimal point using  $\uparrow$ ,  $\downarrow$  button of digital switch.

\*Press RESET button for over 3sec., it returns to RUN mode.

### ●Changing the decimal point

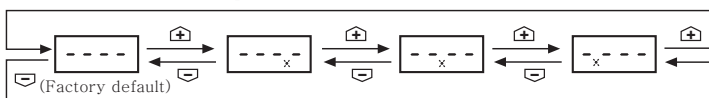

\*It returns to RUN mode if no RESET button or digital switch is applied for 60sec. in decimal point setting status.

\*The decimal point setting is existed in indication type.

# 8 Pin Plug type Counter

## Counting operation of indication mode (Indication model)

### Up mode

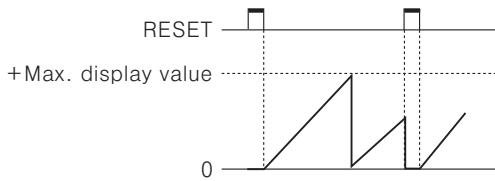

### Down mode

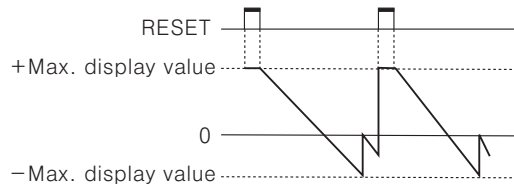

## Output operation mode

		← One-shot output (0.05 to 5sec.)	← Retained output	
Output mode (SW1)	ON  OFF	ON  OFF <b>Up mode</b>	ON  OFF <b>Down mode</b>	Operation after count up
<b>F</b>	6 7 8 ON  OFF			The display value continues until reset signal is applied then output is held. • Retained output will be maintained until Reset signal is applied.
<b>N</b>	6 7 8 ON  OFF			Display value and retained output are maintained until Reset signal is applied.
<b>C</b>	6 7 8 ON  OFF			The display value returns to reset start status when display value is reached to setting value.
<b>R</b>	6 7 8 ON  OFF			The display value is held until output is OFF then returns to reset start status.
<b>K</b>	6 7 8 ON  OFF			The display value continues until reset signal is applied.
<b>P</b>	6 7 8 ON  OFF			The display value is held during one-shot output time, counting process is returned to reset start status as soon as output is ON.
<b>Q</b>	6 7 8 ON  OFF			The display value continues during one-shot output time.
<b>S</b>	6 7 8 ON  OFF			<ul style="list-style-type: none"> <li>• Up input mode –Output is ON when (Display value) ≥ (Setting value)</li> <li>• Down input mode –Output is ON when (Display value) ≤ (Zero)</li> </ul>

\*One-shot output time is set by front TIME adjuster.

- (A) Photo electric sensor
- (B) Fiber optic sensor
- (C) Door/Area sensor
- (D) Proximity sensor
- (E) Pressure sensor
- (F) Rotary encoder
- (G) Connector/Socket
- (H) Temp. controller
- (I) SSR/Power controller
- (J) Counter**
- (K) Timer
- (L) Panel meter
- (M) Tacho/Speed/Pulse meter
- (N) Display unit
- (O) Sensor controller
- (P) Switching power supply
- (Q) Stepping motor & Driver & Controller
- (R) Graphic/Logic panel
- (S) Field network device
- (T) Production stoppage models & replacement

# FS Series

## ■ Proper usage

### ◎ Reset function

#### ● Reset

In case of changing the input mode after supplying the power, please take a external reset or manual reset. **If reset is not executed, the counter will be working as previous mode.**

#### ● Reset signal width

It is reset perfectly when the reset signal is applied during **min. 20ms** regardless of the contact input & solid-state input.

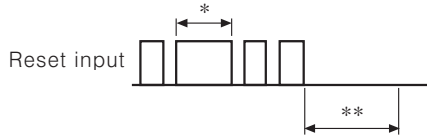

\*In case of a contact reset, it is reset perfectly if the ON time of reset signal is applied during min. 20ms even though chattering is occurred.

\*\*It can be input the signal of CP1&CP2 after min. 50ms from closing time of reset signal.

### ◎ Sensor power

The power 12VDC which is provided to sensor is built in it. Please use it under Max. 50mADC.

### ◎ Min. signal width of CP1, CP2 input

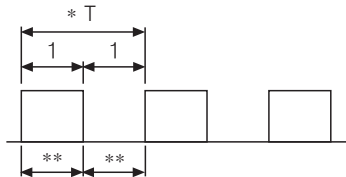

\*Please make duty ratio(ON/OFF) 1:1.

\*\* Min. signal width

- 1cps : Min. 0.5sec.
- 30cps : Min.16.7ms
- 2kcps : Min. 0.25ms
- 5kcps : Min.0.1ms

### ◎ Max. counting speed

This is a response speed per 1 sec. when the duty ratio (ON:OFF) of input signal is 1:1. If the duty ratio is not 1:1, the width between ON and OFF should be over min. signal width and the response speed is getting slower against input signal.

If either ON or OFF signal is shorter than minimum signal width, this product may not respond.

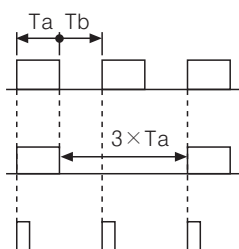

Therefore Ta(ON width) and Tb(OFF width) needed to be over min.signal width.

Max. counting speed is 1/2 value of rated spec. when duty ratio is 1:3.

It can not respond if it is smaller than min. signal width(Ta).

### ◎ Error display

Error signal	Error description	Returning method
Err0	Zero setting status	Change the setting value to non zero status

※When Error is displayed, the output continues OFF state.

※There is no Error function in indicator.

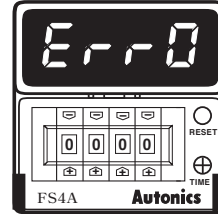

### ◎ Detach the case from body

While pushing the Lock part with with driver to the front, push the terminal block.

1)Widen the lock device toward outside, push the plug to the front.

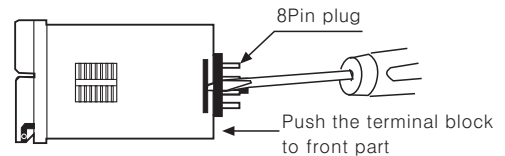

2)Detach the case.

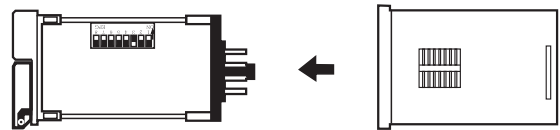

※Please be careful to use with tools, it may cause injury.

### ◎ Power

The inner circuit voltage starts to rise up for the first 100ms after power on, the input may not work at this time. And also the inner circuit voltage drops down for the last 500ms after power off, the input may not work at this time.

